

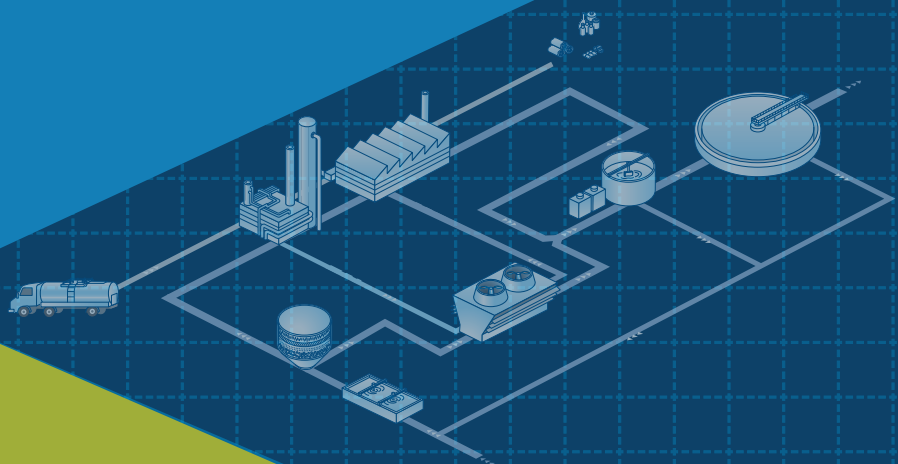

COMPLETE WATER ANALYSIS SOLUTIONS:

# Food Industry





# Your Partner for Water Analysis in the Food Industry

At Hach, we understand your water needs when it comes to ensuring the highest levels of product quality, consistency and safety. Since 1947, Hach Company has designed, manufactured, and distributed world-class instrumentation, test kits, and reagents for testing water quality in a variety of food industry applications, including plant influent, boiler feedwater, product loss reduction, and effluent water treatment.

We invite you to take a look at our comprehensive line of product solutions and services. They're the most accurate and dependable products you can buy.

Hach offers:

- On-line process instrumentation and reagents
- Laboratory equipment, reagents, and supplies
- More EPA-approved methods than any other company
- Portable test kits and field instruments
- Automatic samplers and flow meters
- Local sales and service teams
- Service partnership programs and customized training

Whether your goal is to maintain permit compliance, prevent product loss, or optimize water treatment, Hach has expert answers and complete solutions to help you succeed.

# Water Quality Solutions by Application

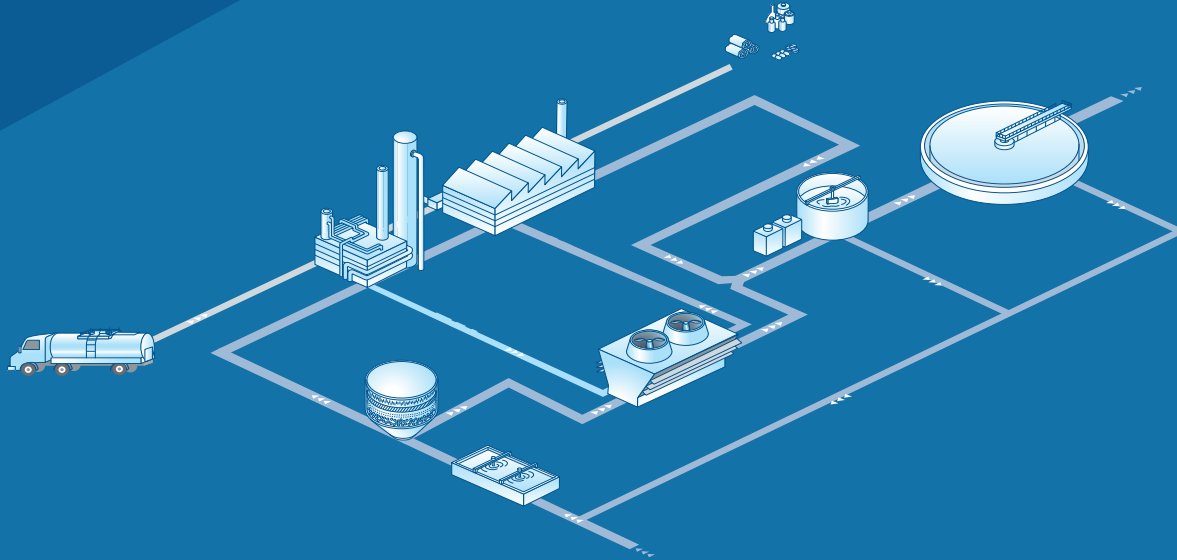

- Boiler Water
- Cooling Towers
- Process Water
- Source Water
- Thermal Process Water
- Water Reuse

## Parameters

Food Industry Applications	Parameters							
	pH	Chlorine	Turbidity / TSS	Dissolved Oxygen	Hardness	Organic Load	Conductivity	Alkalinity
Source & Raw Water	●	●	●		●	●	●	●
Boiler Water & Steam	●			●	●	●	●	●
Cooling & Recirculating Water	●	●	●		●		●	●
Process & Cleaning Water	●	●	●			●	●	
Water Reuse & Recycling	●	●	●			●	●	●
Wastewater & Water Discharge	●	●	●	●		●	●	●

## Hach Solutions

Portable Meter	●	●	●	●			●	●
Laboratory Meter	●	●	●	●	●		●	●
Online Sensor*	●	●	●	●	●	●	●	
Online Analyzer		●	●		●	●		●

\*Requires controller.



Be Right™

## Challenges for Production Water Treatment

- Process control to ensure high product quality, consistency and safety
- Process optimization to control costs
- Comply with environmental regulations
- Protection of equipment

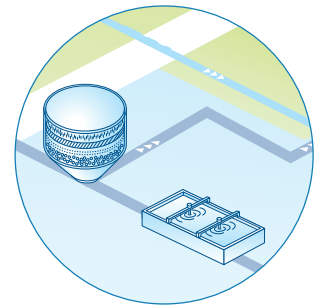

## Challenges for Steam and Utilities Water Treatment

- Optimization of steam generation cycles and condensate recovery to reduce costs and save time
- Optimization of production processes by pure steam
- Protection of equipment, i.e. preventing corrosion or scaling

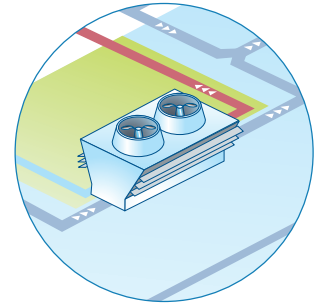

## Challenges for Effluent and Wastewater Treatment

- Comply with environmental regulations
- Optimization of process operation, i.e. effective control of aeration in treatment to reduce energy costs and ensure high quality
- Optimizing chemical usage to control costs and ensure treatment process stability
- Protection of equipment, i.e. preventing corrosion

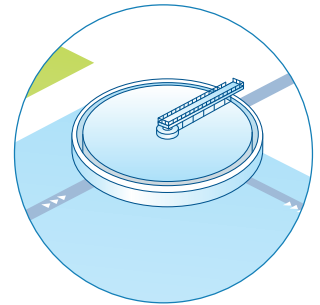

## Key Parameters for Production Water Treatment

### Chlorine

Excessive chlorine harms membrane-based filtration systems and alters taste. Too little chlorine creates an opportunity for microbiological growth. Close monitoring of chlorine levels preserves filtration membranes and prevents the formation of harmful bacteria. Many disinfection programs employ a chlorine, chlorine dioxide or ozone strategy to prevent microbiological growth. Whether raw water, process water, rinse water, or effluent water, constant monitoring of disinfection parameters helps ensure that processes meet product safety, consistency and environmental regulations.

### Conductivity/Total Dissolved Solids (TDS)

Conductivity or TDS, the most widely used control parameter for CIP applications, measures caustic or acidic solution strength. Conductivity also monitors process completion to identify product variation and control chemical additives. Inductive conductivity, sometimes referred to as electrodeless or toroidal, remains the industry's primary choice due to sanitary 3A design standards. Conductivity also determines filtration media efficiency by gauging the dissolved, ionic constituents before and after the filtration process.

### pH / ORP

pH and ORP commonly measure control processes throughout a facility. pH adjustment prior to filtration prevents precipitation of dissolved materials such as silica and calcium carbonate that clog filters. Maintaining proper pH also ensures maximum effectiveness and minimizes the costs of chemical additives, such as disinfectants. ORP monitors the effectiveness of chlorine removal (activated carbon filtration) and controls de-chlorination chemical addition, protecting upstream RO units and reducing chemical costs.

### Turbidity

Depending on the water source, turbidity varies dramatically. Often, filtration systems remove excess turbidity and other minerals. While conductivity also monitors dissolved solids, on-line turbidity measurement is the preferred method to monitor filtration efficiency and control backwashing cycle frequency.

# Key Parameters for Effluent & Wastewater Treatment

## pH

The continuous monitoring of pH plays an important role in alerting a facility of necessary process adjustments well in advance of a violation. Additionally, pH monitoring at various stages within the wastewater treatment process is critical for maintaining bugs' health, optimizing chemical usage, and preventing corrosion to control costs.

## Dissolved Oxygen (DO)

The aeration and activated sludge processes require a steady supply of oxygen to function effectively. Insufficient oxygen results in process inefficiency, producing foul-smelling intermediate products and incomplete reactions. Too much oxygen results in excessive energy loss. Since aeration and activated sludge processes constitute up to 70% of a wastewater plant's energy costs, precise monitoring and control of oxygen allows effective and efficient functionality.

## Turbidity and Total Suspended Solids (TSS)

Turbidity and TSS measurements are commonly used for wastewater discharge reporting. They also control dissolved air flotation systems, dewatering equipment, and clarifier influent. When applied to polymer feed systems, the additional control often results in significant polymer savings. On-line monitoring and regular sampling protocols reduce the potential of putting excessive solids into the wastewater stream and help prevent permit violations and associated fines.

## Nitrogen Removal

Nitrogen enters wastewater treatment plants as Ammonia and is typically removed biologically. Using aeration, the nitrification stage utilizes aerobic bacteria to turn Ammonia into Nitrite and then Nitrate. Nitrogen removal happens as bacteria consume the Oxygen from Nitrate turning it into Nitrogen gas that escapes into the atmosphere. Aeration can account for 70% of operating costs because most wastewater treatment plants run their blowers full speed 24 hours a day, 7 days a week in order to meet permit limits. Using Real-Time control solutions to adjust blowers based on Nitrite and Nitrate levels can significantly reduce energy costs.

## Phosphorus Removal

Phosphorus does not have a gaseous form, so it must be converted from soluble form to particulate form for removal. Chemical phosphorus removal uses iron or aluminum compounds to combine with and precipitate out phosphate. Over treating water with these chemicals, while an effective method for ensuring permit compliance, will result in wasted chemical spend and increased sludge production. This parameter is easily controlled in real-time, meaning that chemical dosing is based on the volume of phosphorus present and not a single set point.

## Dissolved Air Flotation (DAF)

In food processing plants, a DAF is often used to reduce loadings and clarify wastewater. Tiny air bubbles are released into the tank causing small particulates to float to the top where they are skimmed off. To remove larger suspended solids, coagulant is dosed into the feed water—this helps to speed up clumping and settling.

Typically, chemical is dosed to the DAF based on flow rate, but dosing based on flow ignores the solids concentration. This leads to under- and over-dosing which could waste chemicals, increase hauling costs, and result in fines. Real-time data helps facilities dose coagulant based on solids concentrations, eliminating over treating and reducing total costs.

## Organics

In wastewater with high organic loads, a facility uses chemical treatment and physical processing to reduce load levels to those acceptable for either re-use or discharge into the environment. Efficient management of organics typically involves Biological Oxygen Demand (BOD) for reporting purposes. However, since the test takes 5 days, surrogates such as Chemical Oxygen Demand (COD), Total Organic Carbons (TOC), and Spectral Absorption Coefficient (SAC) may be used. These offer quicker test results and early detection of upsets or spills for reduced operational and maintenance costs. COD, a relatively simple lab procedure, reduces testing time to 2 hours. On-line TOC monitoring provides results every 7 minutes and on-line UV254 (SAC) monitors continuously for real-time control.

---

# Key Parameters for Product Loss Reduction

## Organics

Lost product reduction has been a high-ranking objective in the food industry for a long time. Losing otherwise salable product down the drain adds significant cost beyond the product loss itself in the form of higher energy, water, and treatment costs. Using real-time organics monitoring specifically designed for these harsh applications as a management tool allows plants to view and quantify the product in process streams and wastewater, allowing for

more informed process control and incident response ultimately leading to reclaimed profit that would have otherwise been lost.

**PL control allows customer to take immediate/quick corrective actions. A quick response is essential to succeed in PL control.**

# Total Plant Coverage in the Lab

Hach lab instruments are designed to help you easily monitor your water quality at all stages in your plant; from influent to wastewater, process water to cooling water. Our reliable and easy-to-use lab and portable products will help you monitor production and meet compliance objectives.

## PHOTOMETRIC AND COLORIMETRIC



### DR 1900 Spectrophotometer

- The lightest and most compact portable spectrophotometer
- Even in dusty or wet conditions, testing is easy
- With the highest number of preprogrammed methods and an easy-to-use interface



### DR 3900 Spectrophotometer

- Easy step-by-step testing procedure
- Elimination of false readings
- Accurate results every time



### DR 6000 Spectrophotometer

- Accessories for High Volume and High Accuracy Testing Needs
- Guided Procedures and Elimination of False Readings
- Automatically Avoids Errors

### TNTplus® Bar-Coded Chemistries

TNTplus vials work exclusively with the DR 6000, DR 3900, and DR 1900\* Spectrophotometers.

- Error free and fast—instrument automatically detects and runs the correct method
- Easy, accurate recognition—color-coded parameters and ranges
- Best results—10 measurements in one rotation, eliminating outliers; optically superior glassware

*\*Barcode reading, vial spinning, and outlier rejection features not available on DR 1900.*



### DR 900 Colorimeter

- Fastest and simplest water testing for the most demanding field environments
- Field ready in every way possible
- Intuitive user interface
- Simple data communication



### DR300 Pocket Colorimeter

- Robust and waterproof design withstanding extreme conditions
- Accurate and reliable measurement
- Reducing errors and saving time by eliminating manual data entry with optional Bluetooth connectivity
- Simple and intuitive operation to reduce manual error and allows usage under extreme conditions



## SL1000 Portable Parallel Analyzer

- Perform multiple tests faster
- Less variability
- Less hassle

## TU5 Series Laboratory Turbidimeters

Turbidimeters with 360° x 90° Detection™ deliver unprecedented confidence that a change in your reading is a change in your water.

- Matching lab and online results and validate your measurement results
- Fast measurements
- Available Claros Mobile Sensor Management enables remote access to instrument data
- Groundbreaking 360° x 90° Detection™ Technology



## Hach Test Kits

From beakers to colorimeters, everything you need is supplied in Hach Single- and Multi-parameter Test Kits.

- Pre-measured reagents
- Accurate color matching
- Step-by-step instructions
- Upright reagent storage
- Rugged, chemical-resistant cases

## Hach Test Strips

Easy to use for fast and reliable water quality screening.



## ez COD® Recycling for Hach COD Vials

Reduce COD reagent recycling costs and simplify the task of recycling.

- One low price—includes container, pickup, and recycling fees
- Hassle free—place entire vial into receptacle
- Environmentally friendly—Silver and Mercury are reclaimed
- Convenient—order reagents and recycling from one source
- Right sized—pick from three programs based on your annual COD waste output (5, 20, and 55 gallons)

# ELECTROCHEMICAL

## HQd Meters and IntelliCAL™ Probes

Use a single handheld HQd meter and interchangeable IntelliCAL probes for quick, simple, and reliable measurements.

- Designed for your water applications, the Hach HQd smart probes automatically recognize the testing parameter, calibration history, and method settings to minimize errors and set-up time.
- Hach gives measurement flexibility and ease of operation with its HQd portable and benchtop meter and full suite of interchangeable IntelliCAL laboratory and field probes for testing Conductivity, DO, ORP, pH, Ammonia, and many more!



## MP Portable Meters

Hach's MP Meters offer single-handed, portable operation for spot checking the pH, ORP, conductivity, resistivity, Total Dissolved Solids (TDS) and temperature of clean water in production or as a quality check. Sensors are built into an integrated sample cup, allowing for efficient, high-throughput testing of samples from spigots or dip testing. MP Meters are rugged enough for daily process checks in challenging environments.

# TITRAMETRIC AND TOTAL OXIDANTS

## Titralab® AT1000 and KF1000 Series

The Titralab AT1000 Series laboratory analysis systems are one touch, automatic analyzers, covering both Potentiometric Titration (AT1000 Series) and Karl Fischer volumetric Titration (KF1000 Series) with pre-set methods that can quickly deliver accurate and reliable results straight from the box, allowing anyone in the laboratory to immediately perform accurate and reproducible titrations.



## Hach Digital Titrator

Get accurate ( $\pm 1\%$ ), convenient titrations without the bulk, fragility, or waste of a conventional burette. Test for eighteen parameters including chlorine, hardness, and iron. Uses interchangeable titrant cartridges.





# FLOW AND SAMPLING

## AS950 Peristaltic Samplers

Hach AS950 Automatic Samplers collect and store unbiased representative water samples for laboratory analysis. The AS950 is configurable to meet all sampling needs by combining a controller, a base, a bottle set, accessories and sampling program features. Every AS950 is equipped with a peristaltic pump with spring-mounted rollers that provide long tubing life and a standard liquid detect sensor for best-in-class sample volume accuracy. Additionally, the USB connection and an auxiliary port for pulse or 4-20 inputs are standard.



# MICROBIOLOGY

## Microbiology Media

Hach's ready-to-use Microbiology Media eliminates measuring, mixing, and autoclaving necessary to prepare media. Available for testing/ measuring total coliforms, *E. coli*, yeast and mold, Heterotrophic bacteria, PRY, and more.

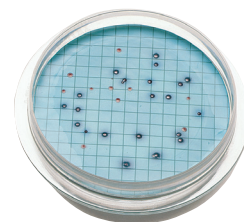

## LuminUltra Total Living Biomass Assessment (ATP)

Microbiological testing solutions provide feedback on contamination sooner for proactive control!

- Detect total active microorganisms in any type of sample
- Results in minutes—not hours or days—for real-time results
- Lab or field operable for maximum flexibility

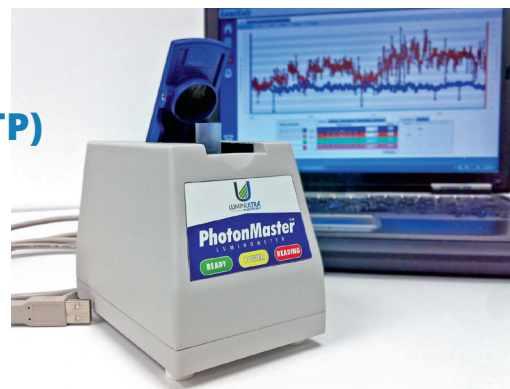

# HACH CHEMISTRIES AND STANDARDS

## Hach Chemical Reagents

A complete system that provides confidence in your test results. Chemical reagents include chlorine, ozone, CO<sub>2</sub>, O<sub>2</sub>, alkalinity, hardness and many more.

- Formulated to minimize interferences, test complexity and analysis time
- Designed for maximum stability and consistency
- Certified by rigorous ISO process procedures



# Production Water Treatment

Proper treatment and conditioning is essential for water as it enters any production process.

The water used in production lines of food facilities must not only meet FDA drinking water standards, it must be treated to remove additional minerals and chemicals which could impact taste and production processes. Hach's on-line process instrumentation provides reliable, real-time readings so you can feel confident your water meets your expectations.

## ALKALINITY

### EZ Series Alkalinity Analyzers

Smart automatic features for validation, priming, and cleaning providing excellent analytical performance and maximized uptime.

- Rugged mainframe with compact footprint
- Flexible adaptation of standard measuring range through different calibration ranges or internal dilution options
- Analysis of up to eight sample streams
- Multiple options for determination of Alkalinity available

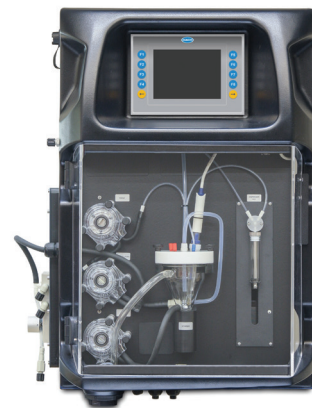

## AMMONIA

### 5500sc Ammonia Monochloramine Analyzer

The 5500sc Ammonia Monochloramine Analyzer provides all the information you need to eliminate nitrification events and taste and odor issues, giving you total confidence in your process.

- An easy-to-operate, low-maintenance solution to help you maintain the proper chlorine to ammonia ratio.
- A user-friendly interface, color coded reagent bottles and at-a-glance status lights will offer peace of mind the instrument is up and running.
- A pressurized system to eliminate the hassles and maintenance that pumps can cause.



## FREE / TOTAL CHLORINE

### CL17sc Colorimetric Chlorine Analyzer

Take control of challenging water treatment processes with an analyzer that maintains accuracy across a wide range of sample conditions.

- Reliable, accurate colorimetric chlorine analysis using DPD chemistry
- Monthly maintenance completed in minutes
- Comprehensive diagnostic features help you verify and troubleshoot quickly and efficiently
- Available Claros Mobile Sensor Management enables remote access to chlorine and instrument data
- Reagent-free solutions for chlorine, chlorine dioxide, and ozone measurements also available

**EPA  
COMPLIANT**



### CLF10 sc and CLT10 sc Free and Total Reagentless Chlorine Analyzers

Hach's answer to reagentless amperometric chlorine measurement.

- Compatible with Hach's "Plug-and-Play" Digital Controllers
- Real time process control
- EPA compliant according to Method 334.0

**EPA  
COMPLIANT**



# CHLORIDE



## EZ Series Chloride Analyzers

The EZ Series Chloride Analyzers offer multiple options to monitor Chloride in water.

- Rugged mainframe with compact footprint
- Flexible adaptation of standard measuring range through different calibration ranges or internal dilution options
- Analysis of up to eight sample streams

# TURBIDITY & SUSPENDED SOLIDS

## TU5300sc/TU5400sc Online Laser Turbidimeters

Turbidimeters with 360° x 90° Detection™ deliver unprecedented confidence that a change in your reading is a change in your water.

- Matching lab and online results and validate your measurement results
- Fast measurements
- Available Claros Mobile Sensor Management enables remote access to instrument data
- Groundbreaking 360° x 90° Detection™ Technology



## FilterTrak 660™ sc Laser Nephelometer

The laser turbidity method used in the FilterTrak 660 sc Laser Nephelometer makes ultra-low measurement of turbidity possible to optimize RO filtration systems.

- 0.0 to 5.0 NTU range
- Detects submicron-size particles, a precursor to larger particles

**EPA  
COMPLIANT**



# HARDNESS



## SP 510 Hardness Monitor

The Hach SP 510 Hardness Monitor continuously monitors water systems to provide an alarm when total hardness exceeds a pre-set limit. By performing an analysis every two minutes, the SP 510 monitor can establish an automatic or semi-automatic system for water softener regeneration.

- Low maintenance—operates unattended for two months
- Low reagent consumption
- Rugged, lightweight, and self-contained

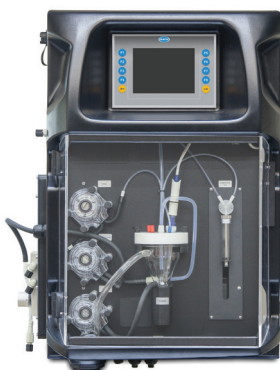

## EZ Series Hardness Analyzers

The EZ Series Online Analyzers offer multiple options to monitor Total Hardness and Calcium Hardness in water.

- Rugged mainframe with compact footprint
- Flexible adaptation of standard measuring range through different calibration ranges or internal dilution options
- Analysis of up to eight sample streams
- Multiple options for determination of Hardness available

# CONDUCTIVITY

## 3700 sc Digital Inductive (Electrodeless) On-Line Sensors

200 to 2,000,000  $\mu\text{S}/\text{cm}$

Monitor CIP and “push water” control with any of Hach/GLI’s Inductive Conductivity Sensors. With no direct contact between the measuring element and the sample, they are contamination and corrosion resistant.

- Rugged, non-fouling, low maintenance design
- Wide measurement range
- Eliminates polarization and electrode coating problems in harsh conditions.



## Contacting Conductivity/Resistivity Sensors

0.057 to 200,000  $\mu\text{S}/\text{cm}$

Monitor membrane health and demineralizer beds with any of these Contacting Conductivity/Resistivity Sensors. Offered in a variety of materials and mounting styles to exacting tolerances to accommodate most configurations.

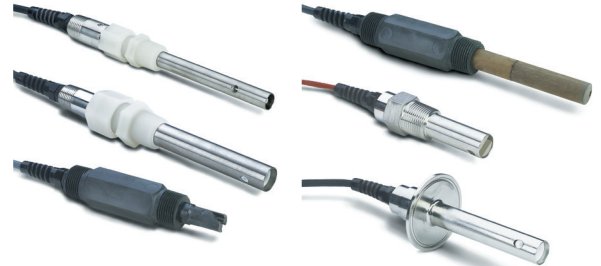

# pH / ORP

## PHD™ Digital Differential On-Line pH/ORP Sensors

For moderate- or high-conductive applications ( $>10 \mu\text{S}/\text{cm}$ ) such as monitoring cooling water blowdown, drum boiler water, or raw water treatment.

- Field-proven differential electrode measurement technique offers better accuracy
- Replaceable salt-bridge/protector simplifies maintenance and extends sensor life
- Sensor requires a Hach sc200 or sc1000 Digital Controller



# TOTAL ORGANIC CARBON

## Hach BioTector B7000 TOC Analyzer

In dairy applications, monitoring and managing product loss is a cost saving initiative. The BioTector B7000 can help pinpoint the source of leaks so you can take corrective action and minimize lost product. Determining the source of production leaks will also help reduce organic load spikes in the wastewater treatment plant, saving the plant on added treatment costs and preventing compliance issues.

- Superior Reliability—Typically 99.7% uptime
- High Dependability—Patented two-stage advanced oxidation (TSAO) technology handles even the most challenging applications
- Smart Design—Self-cleaning technology and oversized tubing eliminates filtration and prevents clogging and sample contamination



# Steam and Utility Water Treatment

Monitoring pH, dissolved oxygen, silica and carbon is essential for keeping the power plant or boiler running properly and protecting capital equipment. Hach's process monitoring solutions for power plants will help you keep your entire facility running by alerting you to potential water quality issues.

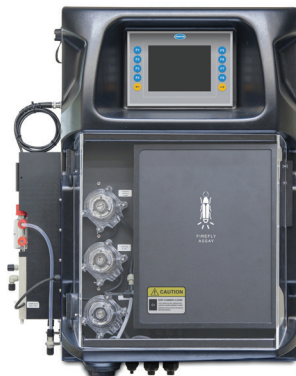

## EZ Series ATP Analyzers

EZ Series ATP Analyzers that offer online monitoring of total bacterial and pathogen load in water.

- Results within minutes
- Complete ATP recovery, differentiating living biomass from non-living
- Complies with ASTM D4012- 81
- Low maintenance

ATP



## EZ Series Hardness Analyzers

The EZ Series Online Analyzers offer multiple options to monitor Total Hardness and Calcium Hardness in water.

- Rugged mainframe with compact footprint
- Flexible adaptation of standard measuring range through different calibration ranges or internal dilution options
- Analysis of up to eight sample streams
- Multiple options for determination of Hardness available

HARDNESS

## 8362 High Purity Water System

Simple to integrate. Simple to operate.

- Works with sc200 platform
- -1500 to +1500 mV ORP range
- 0 to 4 bar (58 psi) pressure range



pH / ORP



## TOTAL ORGANIC CARBON

### Hach BioTector B3500 Series Analyzer

Maximum uptime and reliability for TOC analysis in condensate applications. Using patented technology, only requiring scheduled maintenance every 6 months, allowing for dual stream monitoring, and having one of the most compact analyzer footprints, the Hach BioTector B3500c delivers 99.8% uptime in condensate applications with the lowest operating cost.

- Worry-free TOC
- Lowest Cost of Ownership
- Small footprint = Critical Wall Space Savings
- Reagent Costs that Don't Kill the Bottom Line
- One Instrument for Multiple Streams



# Effluent and Wastewater Treatment

Hach's Real-Time Control solutions optimize your treatment process, saving you operational and treatment costs while helping you maintain permit compliance. Our technology is designed to optimize your entire treatment plant including nutrient removal, sludge treatment and sampling. We offer complete solutions to give you confidence in your water treatment, including predictive diagnostic software to monitor your water quality instruments and a complete service package so you always have access to expert answers.

## DAF TREATMENT

### RTC-ST

Designed for DAF applications specifically for use in sludge thickening devices such as dissolved air, the RTC-ST automatically adjusts a desired specific polymer dosing rate (g Polymer / kg TSS) based on the measured influent total suspended solids (TSS) concentration and feed flow rate. To meet exactly your targeted TSS concentration a feedback controller based on the TSS measurement in thickened sludge can be activated.

If a suspended solids sensor input signal is disrupted, the RTC-ST System automatically refers back to a predefined fixed polymer dosing flow to ensure that your process is stable.



## PHOSPHORUS REMOVAL

### RTC-P

The RTC-P optimizes the phosphorus removal processes by adjusting chemical dosing in real time through the continuous measurement of phosphate concentration and flow, allowing you to maintain consistent effluent phosphorus values and enhance your chemical phosphorus control system for unprecedented chemical savings.

Feel confident that you are staying compliant with your discharge permits and that you are saving time and money on your treatment process.

## NITRIFICATION CONTROL

### RTC-N

Designed specifically for continuously-aerated biological wastewater treatment plants, the RTC-N collects influent and effluent ammonia concentration, flow rate, mixed liquor suspended solids and temperature to calculate the optimal DO set-point necessary to control your aeration system based on your desired effluent ammonia set-point.

### RTC-N/DN

Designed specifically for oxidation ditches and sequencing batch reactors, the RTC-N/DN optimizes nitrogen elimination by determining optimal times for nitrification and denitrification based on the continuous measurement of ammonia and nitrate concentrations. Depending on your treatment system, the controller operates in one of three modes:

- Nitrification control with an ammonia set point
- Denitrification control with a nitrate set point
- Nitrification and denitrification control with both ammonia and nitrate set points

# TOTAL ORGANIC CARBON

## Hach BioTector B7000 TOC Analyzer

A patented self-cleaning oxidation technology enables BioTector analyzers to easily handle difficult samples and significantly reduce the maintenance schedule and costs associated with traditional on-line measurement. BioTector analyzers eliminate build up issues from salts, particulates, fats, oils and greases that lead to drift and high maintenance. Configurations are available for TOC, TOC/TN, and TOC/TN/TP.

- Superior Reliability—Typically 99.7% uptime
- High Dependability—Patented two-stage advanced oxidation (TSAO) technology handles even the most challenging applications
- Smart Design—Self-cleaning technology and oversized tubing eliminates filtration and prevents clogging and sample contamination



# FLOW AND SAMPLING



## AS950 Peristaltic Samplers

Hach AS950 Automatic Samplers collect and store unbiased representative water samples for laboratory analysis. Every AS950 is equipped with a peristaltic pump with spring-mounted rollers that provide long tubing life and a standard liquid detect sensor for best-in-class sample volume accuracy. Additionally, the USB connection and an auxiliary port for pulse or 4-20 inputs are standard.

# AMMONIA



## AMTAX™ sc Ammonia Analyzer

Hach's Amtax sc digital on-site analyzer is designed for the high precision determination of ammonium concentration in wastewater. The analyzer offers a high degree of accuracy and needs only minimal supervision thanks to automatic cleaning and calibration. Amtax sc instruments are ideal for installation directly on the tank edge, for fast reaction times in the closed loop control.

# CONTROLLERS



## Hach Digital Controllers

Use any of the digital family sensors with the sc200 Digital Controller that accepts up to two sensors or the sc1000 Universal Controller that accepts up to eight sensors in any combination.

- Plug-and-play operation without special ordering or software configuration
- Many communication options including MODBUS® and wireless modes

Hach's Digital Sensor family includes ammonia, chlorine, chlorine dioxide, conductivity, DO, Nitrate, ORP, ozone, pH, phosphate, sludge blanket level, suspended solids, turbidity, and UV absorption.

# DISSOLVED OXYGEN

## Hach LDO® Model 2, Optical Process Dissolved Oxygen Probe

Hach's next generation LDO (Luminescent Dissolved Oxygen) Probe requires no calibration for the entire 2 year life of the sensor cap, which means it is ready to start measuring your DO (Dissolved Oxygen) right out of the box. With an added cutting-edge 3D calibration procedure that is conducted prior to shipping, the probe will not drift and is more accurate than ever before.



# pH / ORP

## pHD™ Digital Differential On-Line pH/ORP Sensors

For moderate- or high-conductive applications (>10  $\mu\text{S}/\text{cm}$ ) such as monitoring cooling water blowdown, drum boiler water, or raw water treatment.

- Field-proven differential electrode measurement technique offers better accuracy
- Replaceable salt-bridge/protector simplifies maintenance and extends sensor life
- Sensor requires a Hach sc200 or sc1000 Digital Controller



# ORGANICS

## UVAS sc Sensor, 1 mm, 2 mm or 5 mm, with sc200 Controller

Continuous UV 254 Absorbance/Transmittance measurements with the UVAS sc Sensor can be used to protect plant treatment processes from high organic loads or for surrogate BOD, COD, and TOC measurements, with repeatable, accurate measurement.

- On-line analysis allows treatment plants to operate more efficiently
- Flow through design with no sample chamber and self-cleaning wipers





# SLUDGE LEVEL



## Sonatax sc Sludge Blanket Level Probe

Ideal tool to optimize sludge extraction, manage recirculation, and warn of potential solid wash outs, or process upsets by continuously measuring the depth from the surface or height from the tank floor. Maintenance is reduced with the probe's innovative wiper design. Automatic frequency adjustment provides superior accuracy.

# TURBIDITY AND SUSPENDED SOLIDS

## Solitax<sup>®</sup> sc Sensors

- Accurate, color-independent measurements
- Self-cleaning device prevents erroneous values
- Easy one-point calibration
- Sensors work with a Hach sc200 or sc1000 Digital Controller



# VOLATILE FATTY ACIDS

## EZ Series Volatile Fatty Acids (VFA) Analyzers

The EZ Series VFA Analyzers are single-parameter titrators designed specifically for monitoring (wet) anaerobic digesters.

- Direct titration with minimum volatilization
- Continuous monitoring of the anaerobic process
- Enabling higher loading rate for maximum methane production
- Prevention of digester failure due to VFA accumulation





## A Service Partner for Every Aspect of Your Instrumentation Journey

Hach's Service Promise means you have a committed partner who understands your needs and cares about delivering timely, high-quality service you can trust. Our Technical Support, Field and Bench Service Teams bring unique expertise and work together to help you maintain operational stability, reduce compliance risk, maximize instrument uptime, and ensure data integrity.



### Compatible Instruments

Your commitment to the accuracy of your instruments cannot be left to chance. Keep your high-quality Hach® instruments maintained by the experts to ensure accuracy and peace of mind, knowing you can depend on them and be confident in your results.



### Partnership You Can Trust

Relying on authorized Hach Service experts to problem-solve and find solutions quickly is crucial to your team's success. Connecting with you to maintain and repair the instruments you depend on is Hach's top priority.



### Supporting Your Compliance

Regular maintenance visits and validating documentation provide the support you need to show you are safeguarding your instrumentation's accuracy and meeting compliance requirements.

# Your Partner for Water Analysis in the Food Industry

We invite you to take a look at our comprehensive line of product solutions and services. They're the most accurate, dependable, and cost-effective products you can buy.

Hach offers:

- On-line process instrumentation and reagents
- Laboratory equipment, reagents, and supplies
- More EPA-approved methods than any other company
- Portable test kits and field instruments
- Automatic samplers and flow meters
- Local sales and service teams
- Service partnership programs and customized training

**For more information, visit: [hach.com/industries/food](https://hach.com/industries/food)  
or call toll-free 800-227-4224.**